

**Braun Audio.**

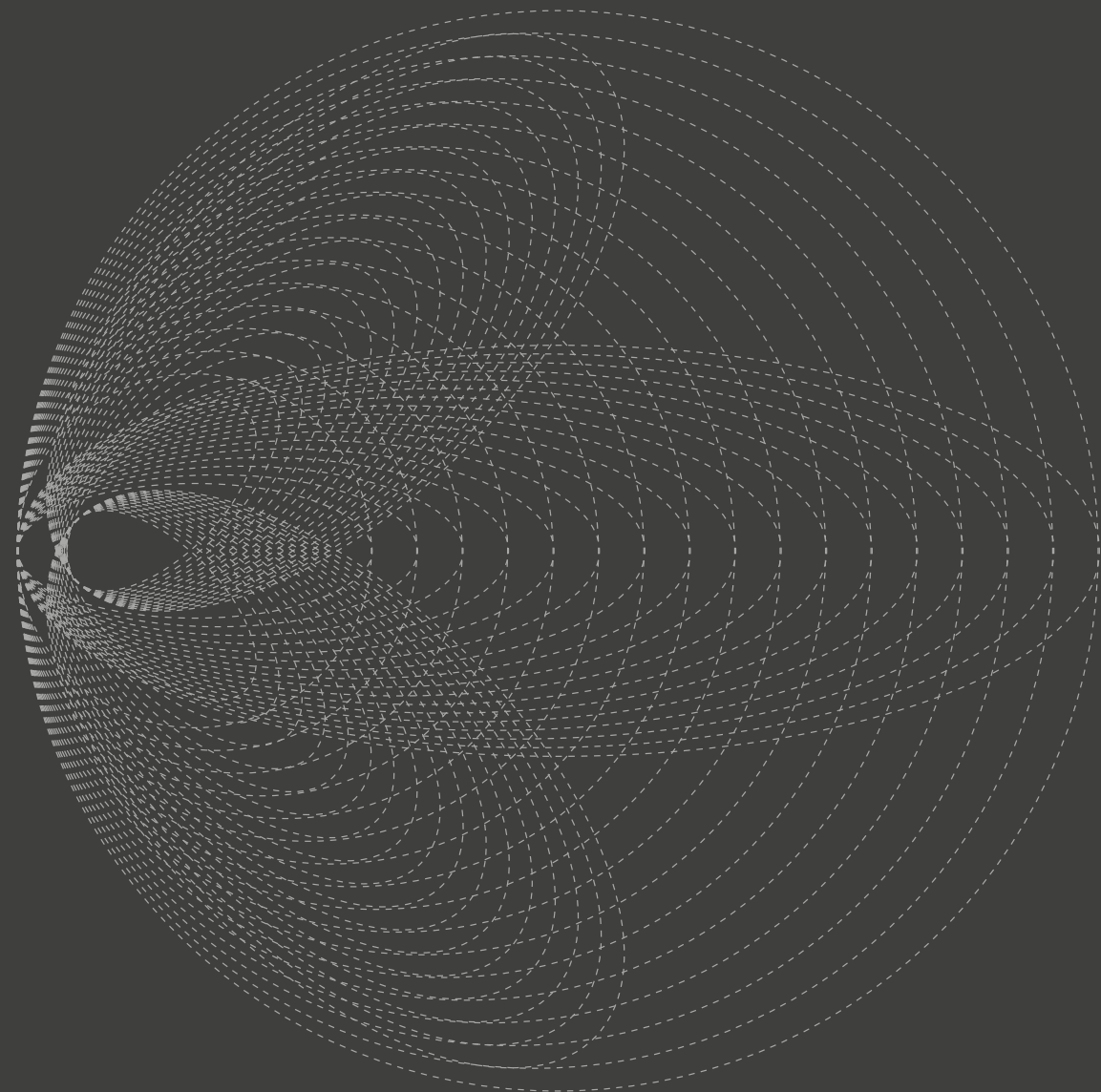

**BRAUN**

**Braun Audio**  
**A welcome return.**

**Purity of design,**  
**purity of performance,**  
**purity of sound.**

**BRAUN**



**Braun Audio.** A welcome return.

## **Designed for what matters.**

Since 1921, Braun has earned the formidable reputation for the creation of iconic designs and human-centred product experiences.

This humanistic focus, combined with the concept of 'less but better' has inspired designers and emulators worldwide for nearly a century.



Braun Audio. A welcome return.

**In tune with the  
way people live  
their lives.**





## Braun Audio world firsts.

From 1956, Braun, under the design stewardship of Dieter Rams, created many audio firsts.

First music system with plexiglass cover. (1)

First mobile music player. (2)

First wall mounted, integrated sound system. (3)

First all-wave receiver. (4)

First company to promote better listening experiences. (5)

First stackable Hi-Fi system, now exhibited at MoMA. (6)

“

... products are not burdened with non-essentials. Back to purity, back to simplicity.”

**Dieter Rams**  
Chief Design Officer  
Braun 1961-1995



1. Braun SK 4, 1956



2. Braun TP 1, 1959



3. L 450/2, TS 45 and TG 60, 1960



4. Braun T 1000, 1963



5. 'Basic rules for Good Hearing' brochure, 1963



6. Braun Atelier (1980-1987)

## Sound foundations.

The ethos of 'less is more' originated with the Bauhaus movement, but it was Dieter Rams that refined and elevated this concept into 'less but better'.

Quality, functionality, clarity and timelessness were values expressed through the hundreds of products created since 1921 and are still fundamental to Braun's approach today.

“

'Good design is innovative... technological development is always offering new opportunities for innovative design. But innovative design always develops in tandem with innovative technology, and can never be an end in itself.'

**Dieter Rams**  
Chief Design Officer  
Braun 1961-1995



## Dieter Rams 10 principles for good design.

In the 1970s, against a backdrop of 'impenetrable confusion of forms, colours and noises', Dieter Rams asked himself an important question: is my design good design?

His answer is expressed in his ten principles for good design.

# Good design

is innovative,  
makes a product useful,  
is aesthetic,  
makes a product understandable,  
is unobtrusive,  
is honest,  
is long-lasting,  
is thorough down to the last detail,  
is environmentally friendly,  
is as little design as possible.

## Braun Audio. Remastered and reimagined.

The LE 1 was state-of-the-art at the time and delivered very clear sound thanks to innovative electrostatic ribbons instead of the more traditional moving-coil cone-shaped transducer.

The clear, precise Braun sound of today has been achieved through the implementation of a bespoke-developed DSP (Digital Signal Processing) pipeline in conjunction with high power ARM computing cores, then hand-tuned in Germany by a world-class audio development team.

LE01 – 2019

LE 1 – 1959





Braun Audio. A welcome return.

## Braun Audio. In tune with today.

From streaming to sharing, from virtual to vinyl, Braun Audio embodies the perfect blend of iconic design, superior acoustic technology and unrivalled German engineering.

Created for today's music lovers, our range of carefully crafted, high performance speakers expertly balance form and functionality, tuned to perfection and built to last.





Braun Audio. A welcome return.

## Braun Audio LE Series.

Purity of design.  
Purity of performance.  
Purity of sound.



---

**LE01**  
The flagship model.



---

**LE02**  
Mid-sized power.



---

**LE03**  
Compact and immersive.



## Braun Audio LE Series.

Iconic, timeless  
performance.

LE is a series of three premium Hi-Fi speakers that celebrate the timeless, essentialist design ethos of their origins, tuned to perfection and built to last.

Expertly blending heritage statements, LE is equipped with the latest in wireless connectivity, voice control, orientation and placement EQ technology and innovation.

Delivering a beautifully dispersed sound stage, the speakers are bold without being intrusive and embody the perfect balance of powerful performance and minimalist form, elegantly showcasing the rigour and care for which German craftsmanship is renowned.





## Braun Audio LE Series.

### Simple and seamless.

Cutting through the complexity of shared, owned and streamed music.

Filling spaces with beautiful Braun sound rather than components and cables.

Visually discreet yet acoustically powerful.

Tonal balance is conserved even at very low volumes.

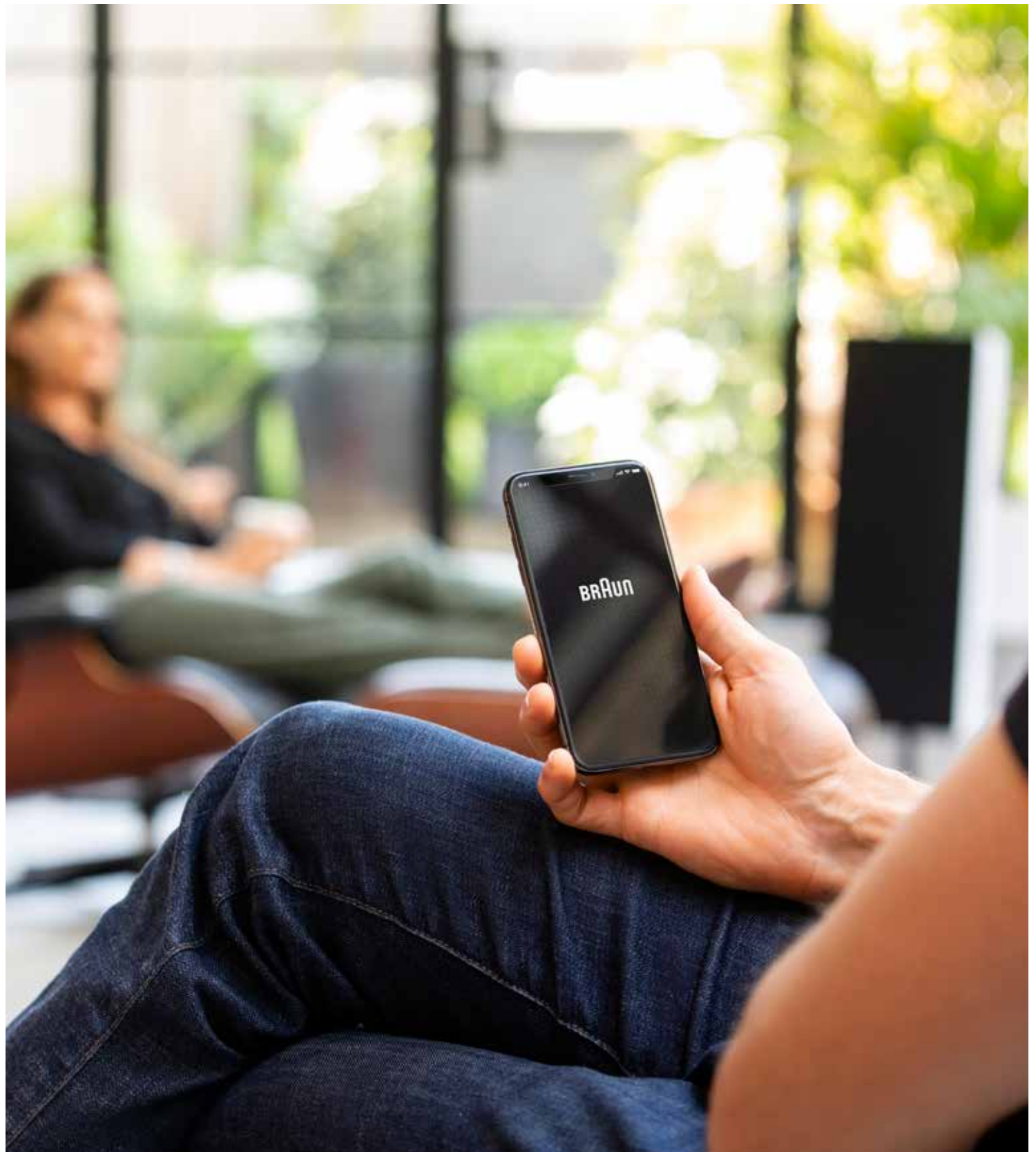

# Braun Audio LE Series.



### Hands-free voice control.

With the Google Assistant you can play music, find answers and manage tasks around the home.



### Play what matters.

Supports over 300 music streaming services with wi-fi streaming.

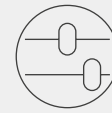

### Fine tuning.

In-app bass and treble tone control.

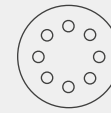

### Future proofed.

Software updates mean you are always up-to-date.



### Privacy on your terms.

Mechanically disconnect the microphones for real privacy.



### Superior sound control.

Placement EQ settings to adapt playback for speaker orientation and location.



### Home integration.

Multi-room set ups and true-stereo.



### Easy connectivity.

Works with Apple AirPlay. Chromecast built-in.

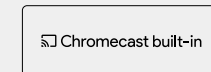



## Braun Audio LE Series.

The mechanical  
privacy button means  
that 'always on' is  
always on your terms.

### **Performance and design.**

Premium machined aluminium body - long-lasting and beautiful.

### **Excellent sound at all volumes.**

All LE speakers are carefully engineered to deliver immersive sound and wide dynamic range that retains crystal clarity, even at very low volumes.

### **Next generation BMR drivers.**

Engineered with state-of-the-art flat profile BMR (Balanced Mode Radiator) drive units, creating a non-directional, panoramic sound stage that saturates the room in beautiful, richly-layered sound.

### **Pairing.**

All LE speakers can be easily paired. When in portrait orientation, using floor stands or wall mounts, LE01 and LE02 can be configured into a wireless stereo pair with each speaker assuming single audio channel duties.

### **Far-field voice recognition.**

Be heard from any point in the room.



## Complementary accessories.

Team with beautifully considered accessories such as wall brackets and floor stands that also elegantly resolve cable management.





## Braun Audio. Tuned to perfection.

### Beautiful, expansive, deeply immersive Braun sound.

The LE 1 of 1959 utilised audio technologies widely considered to be the best available of the time. The re-imagined 2019 LE series leverages the very cutting-edge of today's advanced audio technologies.

Synchronising the latest generation class-D amplifiers and switching power-supplies, Balanced Mode Radiators and low-profile aluminium high-excursion woofers mated to customised quadratic passive radiators, the Braun LE range delivers superior audio clarity, sound dispersion and bandwidth that belies the compact slim-form speaker design.



Question everything  
generally thought to  
be obvious.”

**Dieter Rams**  
Chief Design Officer  
Braun 1961-1995



**Braun Audio.  
Tuned to  
perfection.**

Balanced Mode Radiator  
drive units for truly  
room-filling performance.

Ultra-low-profile metal  
cone woofers for punchy,  
yet refined bass.

Bespoke high-excursion  
passive radiators for  
reduced distortion.

HD-audio integrated  
amplifiers for clarity  
and control.

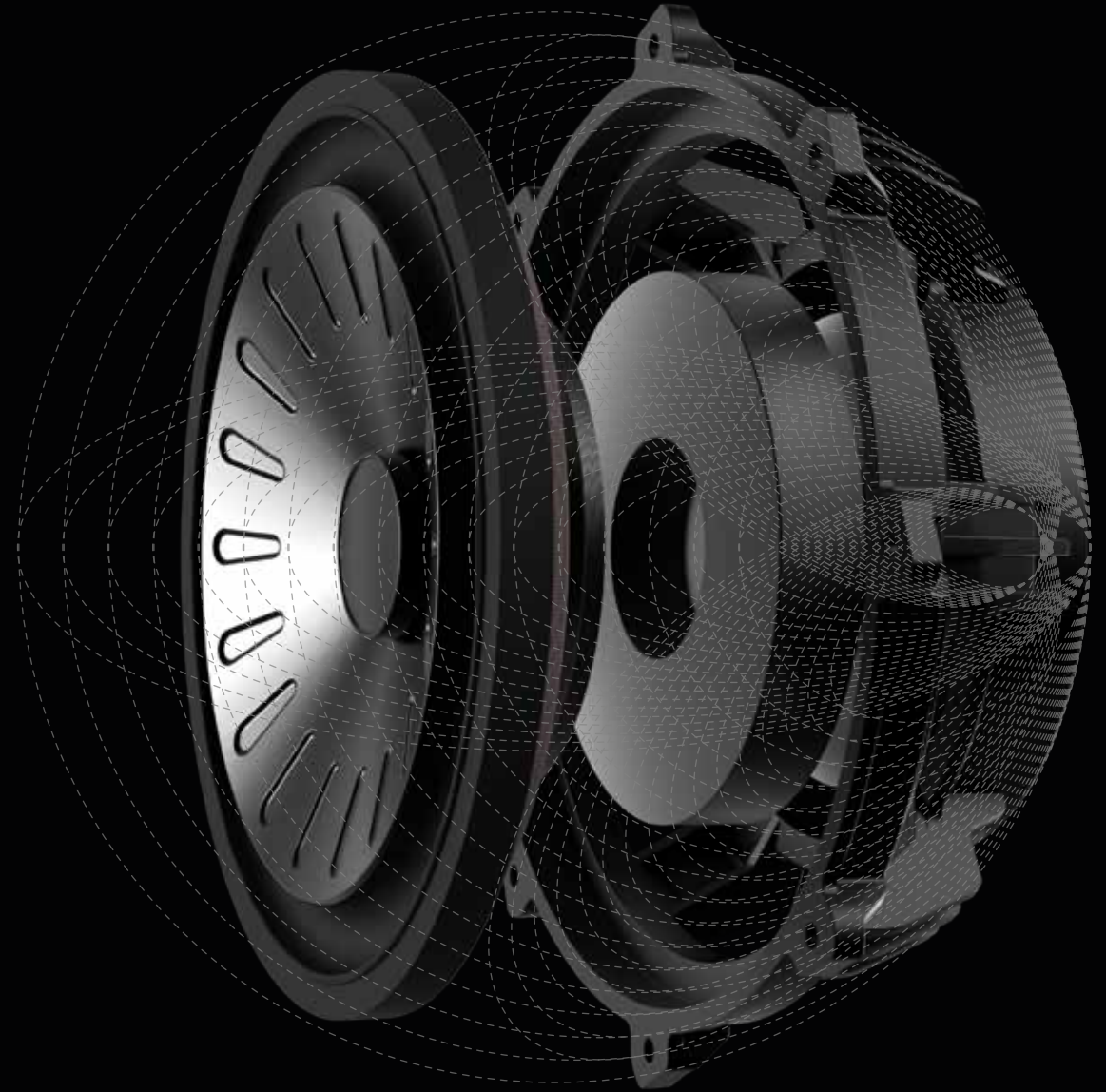



## Building the uniquely Braun sound.



### Room-filling performance with next generation Balanced Mode Radiators.

The Balanced Mode Radiators (BMRs) used in the LE speakers are key to delivering their exceptional audio reproduction. BMRs uniquely combine vertical and horizontal dispersion to deliver a 180-degree sound stage, meaning they are easy to position without worrying about the more constrained sweet spot of a traditional speaker.

Used in conjunction with the woofers and passive radiators, which are custom designed for perfect mating, the use of BMRs enables truly room-filling performance.

### Custom woofers for punchy, refined bass.

Equipped with bespoke designed ultra-low-profile woofers with neodymium motors and light-weight aluminium cones, they offer highly detailed and transient bass. With low-mass, high-rigidity moving parts, they deliver punchy, yet refined, bass performance at all volumes.

### Unique quadratic and racetrack passive radiators for reduced distortion.

Forgoing off-the-shelf, motor-less passives, our engineering team has developed unique, tuned-mass, high-excursion radiators that deliver exceptionally deep and punchy bass, with good sensitivity within the slim

cabinet design. These have a dual progressive linear-suspension construction for increased control and reduced distortion.

### HD-audio integrated amplifiers for clarity and control.

The LE range features the latest generation of HD-audio integrated amplifiers. These are of monolithic class-D design, with all channels actively filtered and managed by advanced DSP algorithms to maximise the inherent clarity and control. As with many silicon technologies, these latest generation integrated amplifiers are at the forefront of performance and power-efficiency.

### Featuring TalkTo™ by DSP Concepts, the latest solution for voice control performance.

TalkTo™ by DSP Concepts features Multichannel Acoustic Echo Cancellation (AEC) software, which cancels the sound from the speaker so the microphones can accurately hear the user's voice.

AEC, when working in conjunction with the TalkTo™ Adaptive Interference Canceller (AIC) - which cancels out noise from other sources, such as from air conditioning or television - enables the speaker to hear voice commands to the Google Assistant more effectively.

Braun Audio. A welcome return.

## The flagship model.

A smart speaker that beautifully delivers expansive, deeply immersive Braun sound and wide dynamic range with consistent crystal clarity.



# LE01

Braun Audio. A welcome return.

The flagship  
model.

# LEO1





Braun Audio. A welcome return.

## Mid-sized power.

Uniquely powerful with wide  
dynamic range.

A premium, mid-sized  
speaker delivering an  
immersive Braun sound  
experience.



# LE02



Braun Audio. A welcome return.

**Mid-sized  
power.**



# LEO2

Braun Audio. A welcome return.

**Compact and  
immersive.**

A perfectly scaled Braun  
speaker, elegantly compact  
with wide dynamic range and  
immersive sound.

LEO3





Braun Audio. A welcome return.

**Compact and  
immersive.**



# LE03

## LE Series. Details matter.

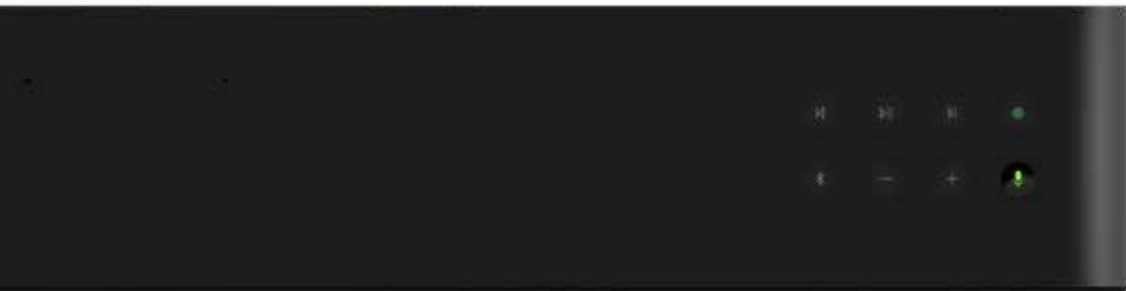
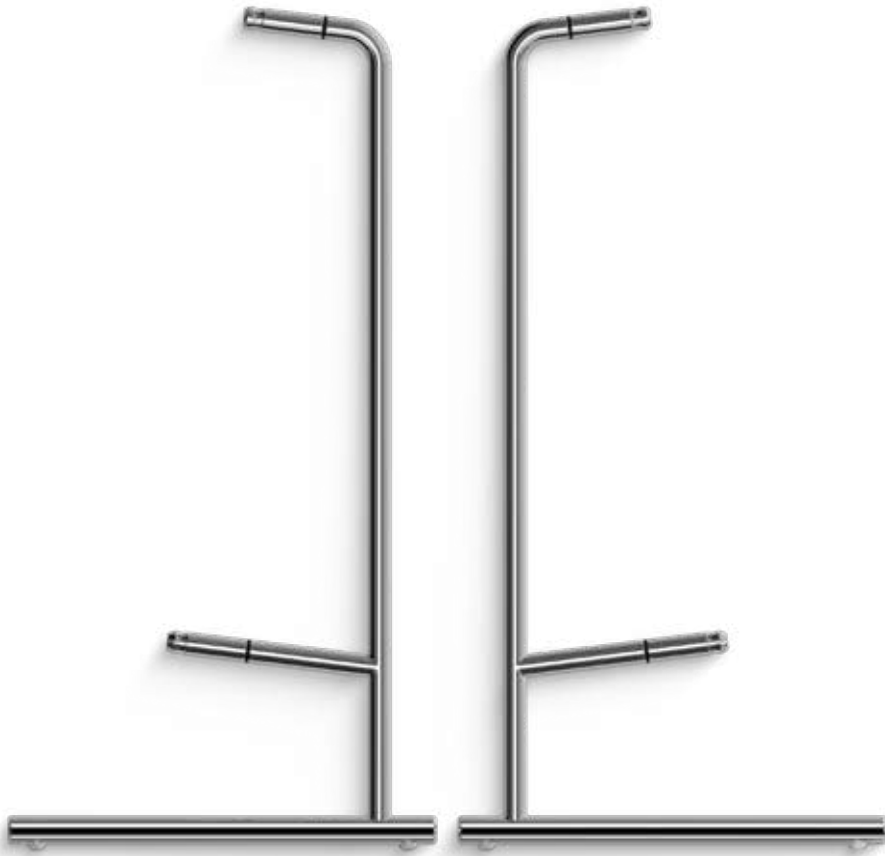

'Design should not dominate things, should not dominate people. It should help people. That's its role.'

**Dieter Rams**  
Chief Design Officer  
Braun 1961-1995

# LE01

## Details matter.

### Design.

#### Dimensions

Speaker: 700 (W) x 271 (H) x 99 (D)  
Speaker with table top stand: 700 (W) x 323 (H) x 159 (D)

#### Materials

Aluminium speaker trim  
Laser cut aluminium rear grille  
Ultrasonic welded acoustic cloth speaker grille cover  
Stainless steel custom supporting feet

#### Finish

Black, White

### Sound.

#### Operating modes

Single LE01 unit – Integrated stereo speaker (landscape orientation), Mono (portrait orientation)  
2 x LE01 units stereo paired – Left/ right channel stereo

#### Audio technology

2 x custom designed 5.25" aluminium cone high-excursion fast-transient woofers with NdFe motors  
3 x full-range 2.5" Balanced Mode Radiator drive units  
2 x race track/quadratic 8" x 4.5" customised passive radiators  
3 x monolithic HD class-D power amplifiers  
32-bit ARM core digital signal processor for high accuracy and low noise  
Frequency response: 62 Hz - 21500 Hz (-6dB)  
96kHz/24-bit HD audio streaming  
Supported audio formats: HE-AAC, LC-AAC, MP3, Vorbis, WAV (LPCM), FLAC, Opus

#### Audio inputs

Apple Airplay 2  
Chromecast™ built-in  
Bluetooth® 4.2 with AAC  
3.5mm Aux-in

### Features.

Room placement audio EQ optimisation  
Auto source switching (Wi-Fi, Bluetooth, Aux)  
Multiroom & stereo pairing: Airplay 2, Chromecast  
Bass & treble tone control (in App)  
Dual-positioned 4-microphone beamforming arrays for far-field voice recognition and acoustic echo-cancellation  
Physical privacy button to disconnect the microphones

#### Controls

Voice: the Google Assistant  
Physical controls: privacy button, action button, play/pause, track skip forward, track skip back, volume +, volume –, Bluetooth pairing

#### Networking

Wi-Fi dual band (WLAN 802.11a/b/g/n/ac, 2.4 and 5 GHz)  
10/100 Mbps Ethernet port

### What's in the box.

LE01 speaker  
1.5m AC power adaptor  
Stainless steel natural finish table top stand  
Silicone feet  
Quick start guide  
Safety sheet

### Accessories. (sold separately)

Floor stand  
Wall bracket

### Good to know.

#### Compatibility

An iPhone or iPad with iOS 10.3 and higher  
An Android™ phone running Android 5.0 and higher  
An Android tablet running Android 6.0 and higher

#### Warranty

2-year warranty

#### Electrical & environmental performance

Operational temperature range: 0 C to 40 C  
Storage temperature range: 0 C to 40 C  
Operational humidity range: 10% to Max 90% (No condensation)  
Storage humidity range: 10% to Max 90% (No condensation)  
UV Degradation: No degradation due to UV for 3 years  
Line voltage: 100V to 240V AC  
Frequency: 50Hz to 60Hz

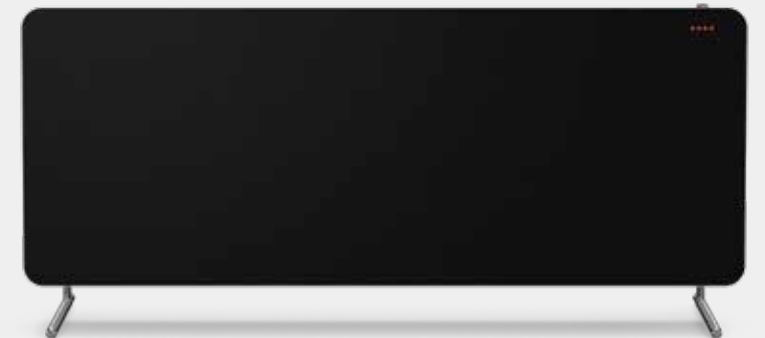



# LE02

## Details matter.

### Design.

#### Dimensions

Speaker: 480 (W) x 171 (H) x 84.5 (D)  
Speaker with table-top stand: 480 (W) x 210 (H) x 131.5 (D)

#### Materials

Aluminium speaker trim  
Laser cut aluminium rear grille  
Ultrasonic welded acoustic cloth speaker grille cover  
Stainless steel custom supporting feet

#### Finish

Black, White

### Sound.

#### Operating modes

Single LE02 unit – Integrated stereo speaker (landscape orientation), Mono (portrait orientation)  
2 x LE02 units stereo paired – Left/right channel stereo

#### Audio technology

1 x custom designed 5.5" aluminium cone high-excursion fast-transient woofers with NdFe motors  
2 x full-range 2.25" Balanced Mode Radiator drive units  
2 x race track/quadratic 6" x 3.5" customised passive radiators  
2 x Monolithic HD class-D power amplifiers  
32-bit ARM-core digital signal processor for high accuracy and low noise  
Frequency response: 67 Hz - 20500 Hz (-6dB)  
96kHz/24-bit HD audio streaming  
Supported audio formats: HE-AAC, LC-AAC, MP3, Vorbis, WAV (LPCM), FLAC, Opus

#### Audio inputs

Apple Airplay 2  
Chromecast™ built-in  
Bluetooth® 4.2 with AAC  
3.5mm Aux-in

### Features.

Room placement audio EQ optimisation  
Auto source switching (Wi-Fi, Bluetooth, Aux)  
Multiroom & stereo pairing: Airplay 2, Chromecast  
Bass & treble tone control (in App)  
Dual-positioned 4-microphone beamforming arrays for far-field voice recognition and acoustic echo-cancellation  
Physical privacy button to disconnect the microphones

#### Controls

Voice: the Google Assistant  
Physical controls: privacy button, action button, play/pause, track skip forward, track skip back, volume +, volume –, Bluetooth pairing

#### Networking

Wi-Fi dual-band (WLAN 802.11a/b/g/n/ac, 2.4 and 5 GHz) 10/100 Mbps  
Ethernet port  
10/100 Mbps Ethernet port

### What's in the box.

LE02 speaker  
1.5m AC power adaptor  
Stainless steel natural finish table top stand  
Silicone feet  
Quick start guide  
Safety sheet

### Accessories. (sold separately)

Floor stand  
Wall bracket

### Good to know.

#### Compatibility

An iPhone or iPad with iOS 10.3 and higher  
An Android™ phone running Android 5.0 and higher  
An Android tablet running Android 6.0 and higher

#### Warranty

2-year warranty

#### Electrical & environmental performance

Operational temperature range: 0 C to 40 C  
Storage temperature range: 0 C to 40 C  
Operational humidity range: 10% to Max 90% (No condensation)  
Storage humidity range: 10% to Max 90% (No condensation)  
UV Degradation: No degradation due to UV for 3 years  
Line voltage: 100V to 240V AC  
Frequency: 50Hz to 60Hz

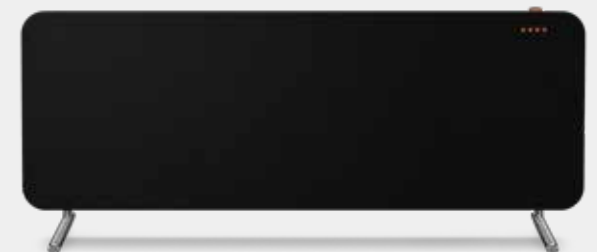

# LE03

## Details matter.

### Design.

#### Dimensions

170 (W) x 170 (H) x 84 (D)

#### Materials

Aluminium speaker trim  
Ultrasonic welded acoustic cloth  
speaker grille cover

#### Finish

Black, White

### Sound.

#### Operating modes

Single LE03 unit – Mono  
2 x LE03 units stereo paired – Left/  
right channel stereo

#### Audio technology

1 x Custom-designed 3.5" aluminium  
cone high-excursion  
fast-transient woofer with NdFe  
motor  
1 x Full-range 1.5" Balanced Mode  
Radiator drive unit  
1 x Race track/quadratic 5" x 3"  
Customised passive radiator  
1 x Monolithic class-D power  
amplifier  
Frequency response: 70 Hz - 21000  
Hz (-6dB)  
32-bit ARM-core digital signal  
processor for high accuracy & low  
noise  
96kHz/24-bit HD audio streaming  
Supported audio formats:  
HE-AAC, LC-AAC, MP3, Vorbis,  
WAV (LPCM), FLAC, Opus

#### Audio inputs

Apple Airplay 2  
Chromecast™ built-in  
Bluetooth® 4.2 with AAC  
3.5mm Aux-in

### Features.

Room placement audio EQ  
optimisation  
Auto source switching (Wi-Fi,  
Bluetooth, Aux)  
Multi-room & stereo pairing:  
Airplay 2, Chromecast  
Bass & treble tone control (in App)  
2-microphone beamforming array  
for far-field voice recognition and  
acoustic echo-cancellation  
Physical privacy button to  
disconnect the microphones

#### Controls

Voice: the Google Assistant  
Physical controls: privacy button,  
action button, play/pause, volume +,  
volume -, Bluetooth pairing

#### Networking

Wi-Fi dual band (WLAN 802.11a/b/  
g/n/ac, 2.4 and 5 GHz)

### What's in the box.

LE03 speaker  
1.5m AC power adaptor  
Silicone feet  
Quick start guide  
Safety sheet

### Accessories. (sold separately)

Floor stand  
Wall bracket

### Good to know.

#### Compatibility

An iPhone or iPad with iOS 10.3 and  
higherAn Android™ phone running  
Android 5.0 and higherAn Android  
tablet running Android 6.0 and  
higher

#### Warranty

2-year warranty

#### Electrical & environmental performance

Operational temperature range:  
0 C to 40 C

Storage temperature range:  
0 C to 40 C

Operational humidity range: 10% to  
Max 90% (No condensation)

Storage humidity range: 10% to Max  
90% (No condensation)

UV Degradation: No degradation  
due to UV for 3 years

Line voltage: 100V to 240V AC

Frequency: 50Hz to 60Hz





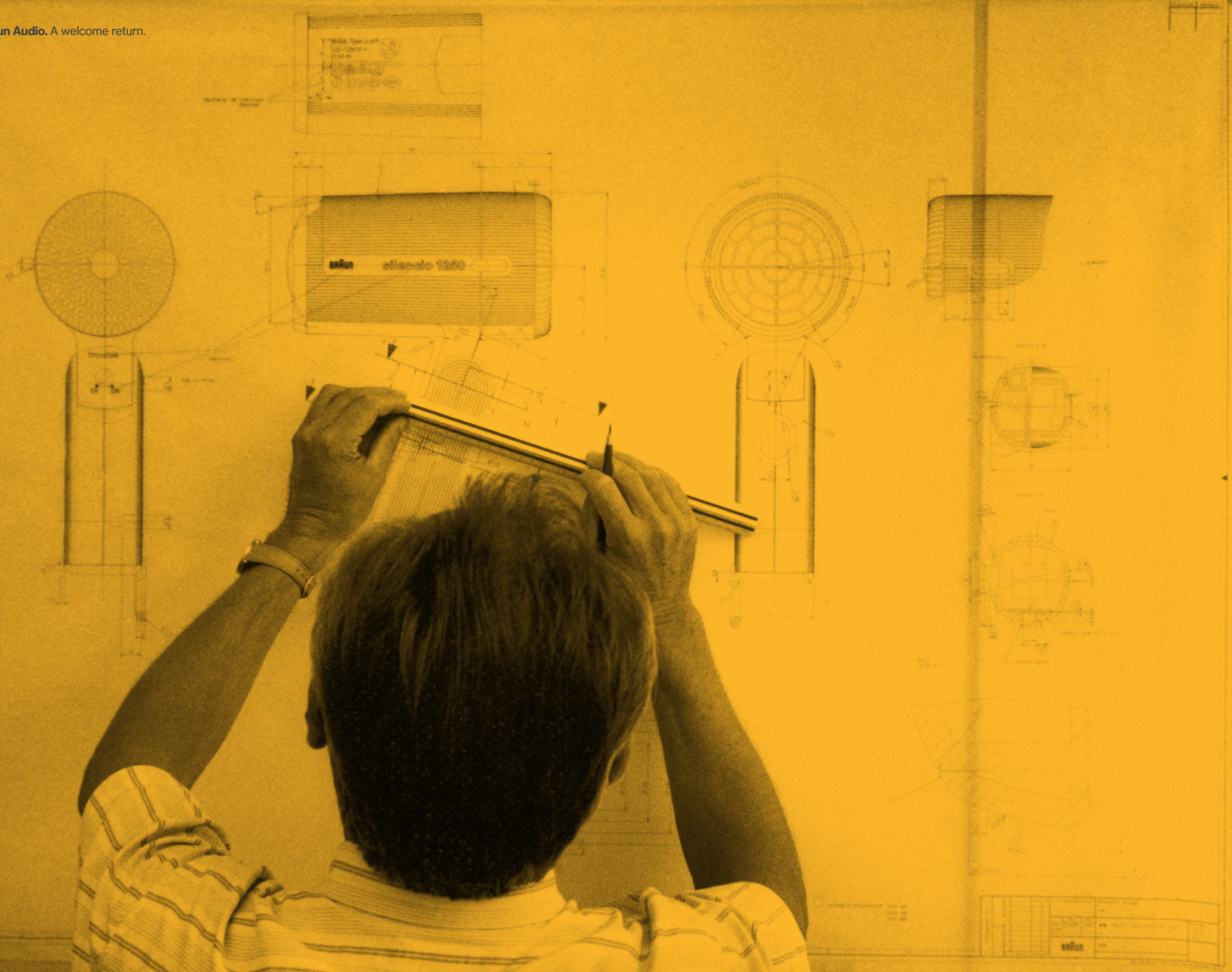



Braun Audio. A welcome return.

# Braun Audio.

**For more information  
please contact:**

info@braun-audio.com

**Follow us:**

 @BraunAudioGlobal  
@BraunAudioDACH

 @BraunAudio

 @Braun\_Audio

 @BraunAudio

 Braun Audio blog

## braun-audio.com

Stands featured within this brochure  
are not supplied with the speakers.  
E&OE.

Braun Audio reserves the right to  
amend details of the specifications  
without notice in line with technical  
developments.

Certain trademarks used under license  
from The Procter & Gamble company  
or its affiliates.

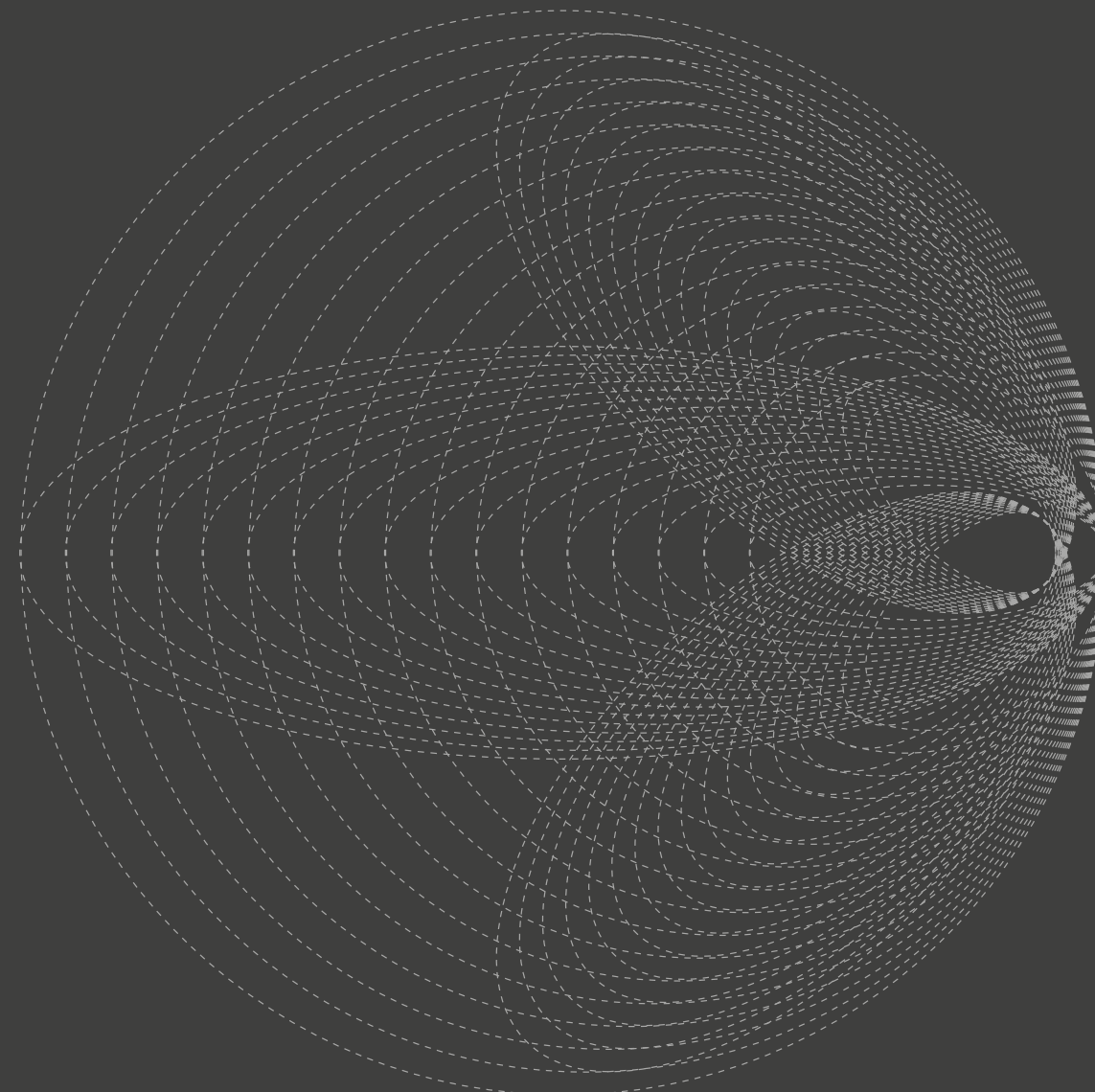

braun-audio.com